



# Glowrail

spec sheet

## Main Features

- High output LEDs with evenly diffused finish
- Brushed stainless finish - 304 or 316 grade or Anodised Aluminium
- Available in curved/straight/angular sections
- 50 000+ hr lifetime to 80% output.
- Standard, High + Super High Output versions to meet any lux requirements
- Emergency compatible with remote 3hr battery unit to full output

Glowrail by The Light Lab



Glowrail

# Product Details Glowrail

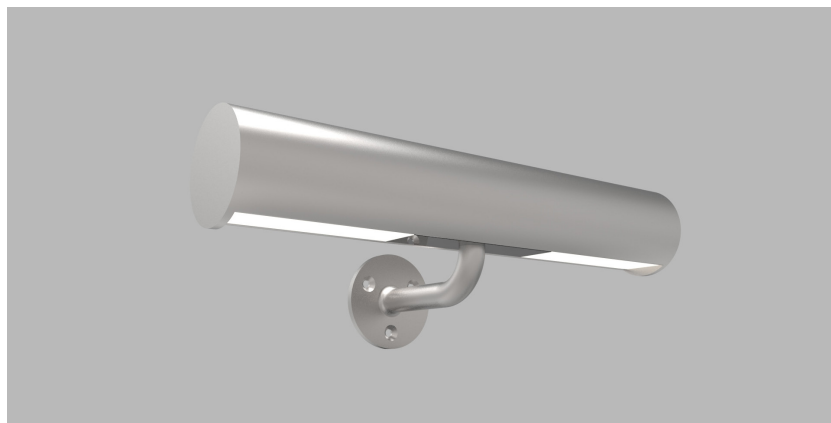

## Specification

	SO	HO	SHO
Diameter	48.3mm	48.3mm	48.3mm
Colours	3.0K/4.0K/5.0K	2.7K/3.0/3.5K/ 4.0K/5.0K	3.0K/3.5K/4.0K 5.0K
Input Voltage	24Vdc	24Vdc	24Vdc
Power Consumption	9.6W/m	14W/m	18W/m
Luminaire Efficiency	56 lm/W	78 lm/W	78 lm/W
IP Rating	IP44 or IP65	IP44 or IP65	IP 44 or IP65
Emergency Compatible	Yes to Full Output	Yes to Full Output	Yes to Full Output
Fixing Type	Wall or Glass	Wall or Glass	Wall or Glass

### Order code

CALL TO QUOTE PER PRODUCT APPLICATION

### Drivers

non-dimmable power supplies:

1-10V /DALI/DMX dimmable power supplies to be ordered seperately

Please call our sales team who will make sure specification suits application

Glowrail by The Light Lab



## Fixing Methods

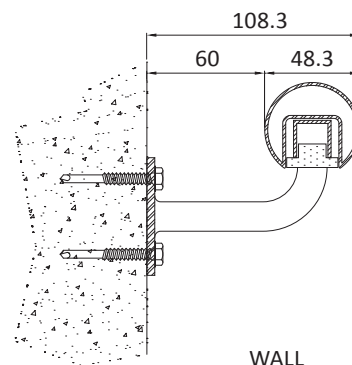

WALL

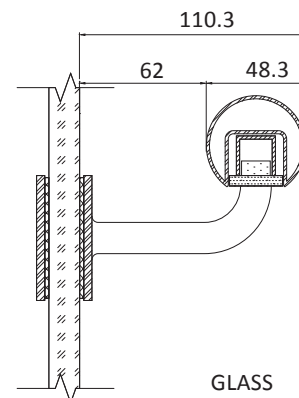

GLASS

## Photometric Info

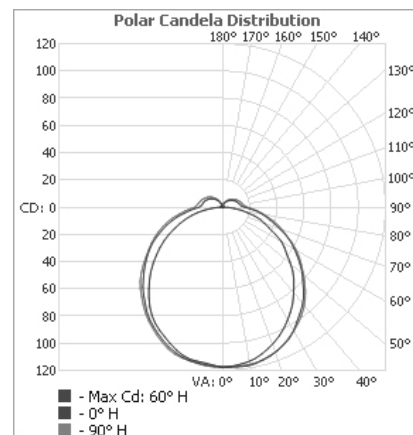

The Light Lab  
22 Holywell Row  
London EC2A 4JB  
United Kingdom  
+44 (0) 207 278 2678  
@thelightlabtd  
www.thelightlab.com

Project Images

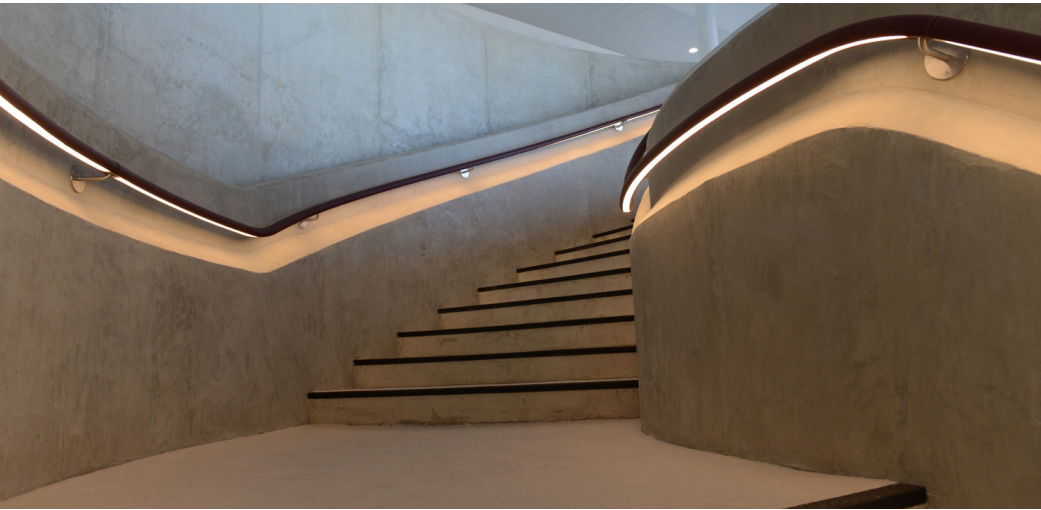

Hiscox, York



New Court, London

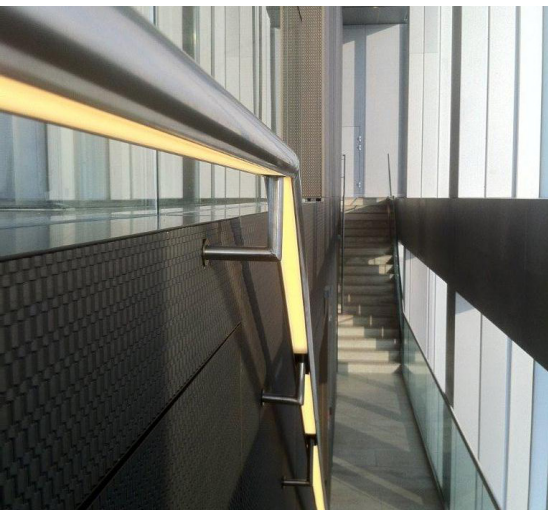

New Court, London



Liberty Specialist Markets

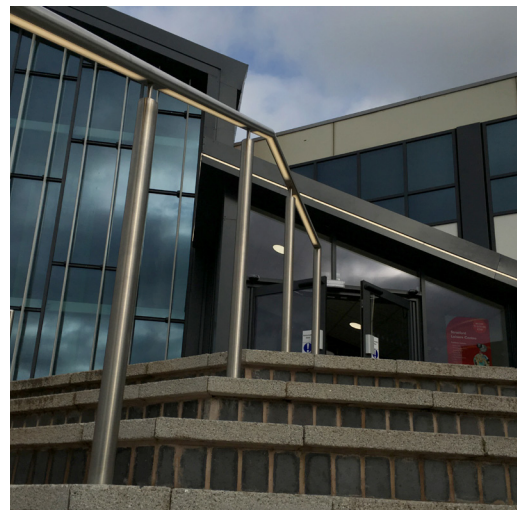

Stratford Leisure Centre



Liberty Specialist Markets

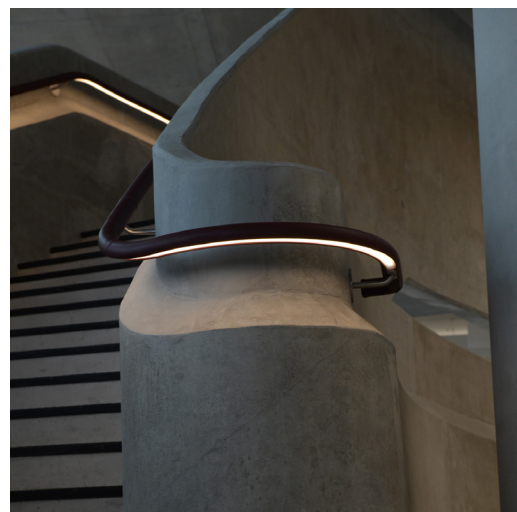

Hiscox, York