



Glowline

spec sheet

Main Features

- Even linear light appearance with ability to butt fittings together with uninterrupted light
- Installation sleeve available for first fix
- Flush or proud variations
- 50 000+ hr lifetime expectancy
- 24 Vdc SELV voltage
- IP44 or IP65 interior/exterior application
- Magnet fixings for simple installation
- Standard, high & super high outputs
- Wide range of colour temperatures to suit



GL12
GL16
GL20
GL25
GL50

Product Details GL12

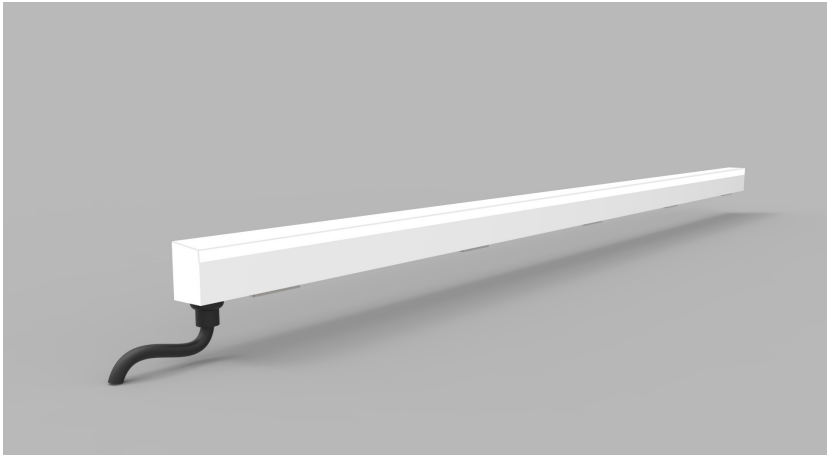

Specification

	SO
Length	115mm to 2965mm in 50mm increments
Colour	3.0K/4.0K/5.0K
Input Voltage	24Vdc
Power Consumption	9.6 W/m
Luminaire Efficiency	56 lm/W
IP Rating	IP44 or IP65
Type	Flush or Proud

Order code

GL12-LENGTH-COLOUR-TYPE-IP-FIXING
 e.g. GL25-XXmm-2.7K-FLUSH-IP44-VC

WIDTH	LENGTH	COLOUR	TYPE	IP	FIXING
GL12	XXmm	3.0K	Flush	IP44	S
		4.0K	Proud	IP65	C
		5.0K			PLS

Drivers

non-dimmable power supplies:
1-10V /DALI/DMX dimmable power supplies to be ordered seperately

Please call our sales team who will make sure specification suits application

Glowline by The Light Lab



Fixing Methods

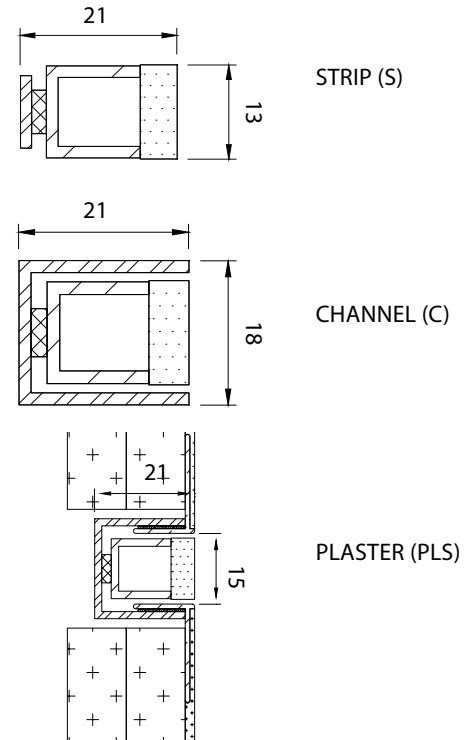

Photometric info

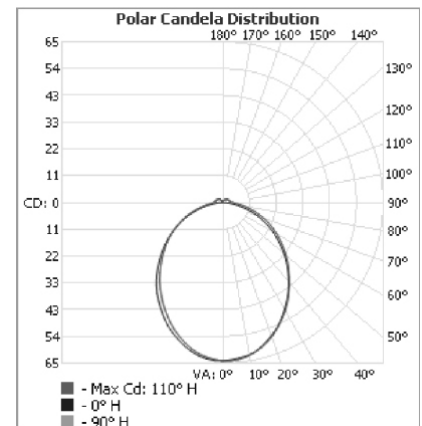

The Light Lab
 22 Holywell Row
 London EC2A 4JB
 United Kingdom
+44 (0) 207 278 2678
 @thelightlabtd
 www.thelightlab.com

Product Details GL16

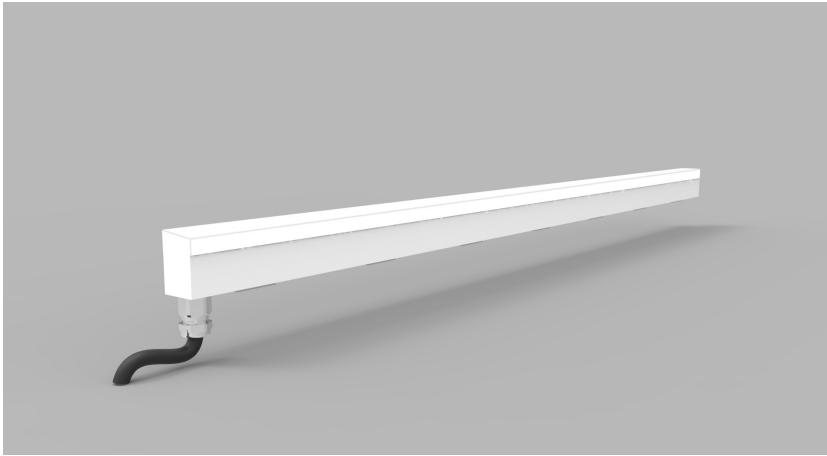

Specification

	SO	HO	SHO
Length	115mm to 2965mm in 50mm increments	115mm to 2965mm in 50mm increments	115mm to 2965mm in 50mm increments
Colour	3.0K/4.0K/ 5.0K	2.7K/3.0K/3.5K/ 4.0K/5.0K	2.7K/3.0K/3.5K/ 4.0K/5.0K
Input Voltage	24Vdc	24Vdc	24Vdc
Power Consumption	9.6 W/m	14 W/m	18 W/m
Luminaire Efficiency	56 lm/W	78 lm/W	78 lm/W
IP Rating	IP44 or IP65	IP44 or IP65	IP44 or IP65
Type	Flush or Proud	Flush or Proud	Flush or Proud

Order code

GL16-LENGTH-OUTPUT-COLOUR-TYPE-IP-FIXING
e.g. GL16-XXmm-SO-2.7K-FLUSH-IP44-VC

WIDTH	LENGTH	OUTPUT	COLOUR	TYPE	IP	FIXING
GL16	XXmm	SO	2.3K	Flush	IP44	S
		HO	2.7K	Proud	IP65	C
		SHO	3.0K			PLS
			3.5K			
			4.0K			
			5.0K			

Drivers

non-dimmable power supplies:
1-10V /DALI/DMX dimmable power supplies to be ordered separately

Please call our sales team who will make sure specification suits application

Glowline by The Light Lab



Fixing Methods

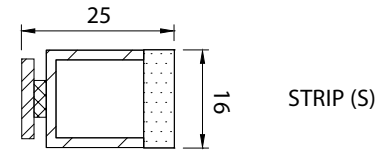

STRIP (S)

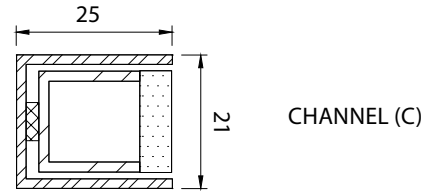

CHANNEL (C)

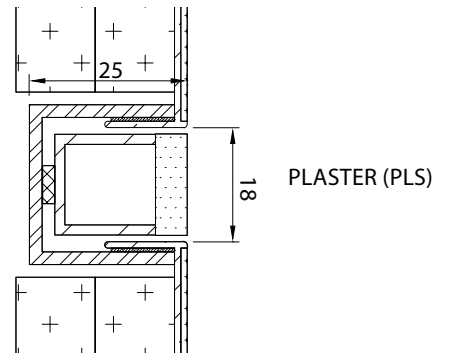

PLASTER (PLS)

Photometric Info

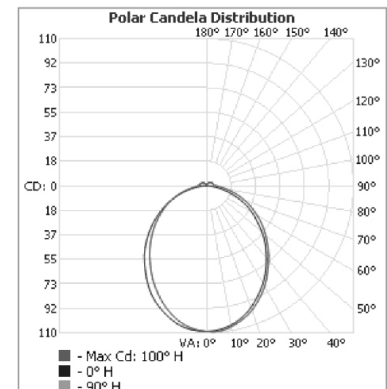

The Light Lab
22 Holywell Row
London EC2A 4JB
United Kingdom
+44 (0) 207 278 2678
@thelightlabtd
www.thelightlab.com

Product Details GL20

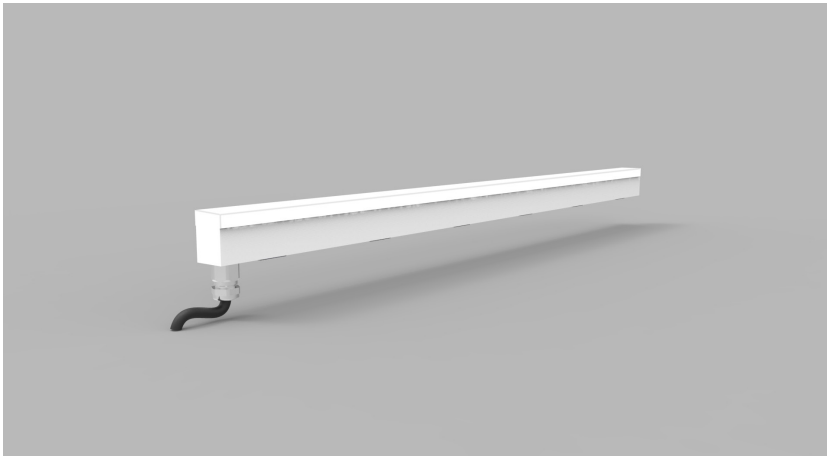

Specification

	SO	HO	SHO
Length	Any length up to 3.0m	Any length up to 3.0m	Any length up to 3.0m
Colour	3.0K/4.0K/5.0K	2.7K/3.0K/3.5K/4.0K/5.0K	2.7K/3.0K/3.5K/4.0K/5.0K
Input Voltage	24Vdc	24Vdc	24Vdc
Power Consumption	9.6 W/m	14 W/m	18 W/m
Luminaire Efficiency	56 lm/W	78 lm/W	78 lm/W
IP Rating	IP44 or IP65	IP44 or IP65	IP44 or IP65
Type	Flush or Proud	Flush or Proud	Flush or Proud

Order code

GL20-LENGTH-OUTPUT-COLOUR-TYPE-IP-FIXING
 e.g. GL25-XXmm-SO-2.7K-FLUSH-IP44-VC

WIDTH	LENGTH	OUTPUT	COLOUR	TYPE	IP	FIXING
GL20	XXmm	SO	2.3K	Flush	IP44	S
		HO	2.7K	Proud	IP65	C
		SHO	3.0K			PLS
			3.5K			
			4.0K			
			5.0K			

Drivers

non-dimmable power supplies:
 1-10V /DALI/DMX dimmable power supplies to be ordered separately

Please call our sales team who will make sure specification suits application

Glowline by The Light Lab



Fixing Methods

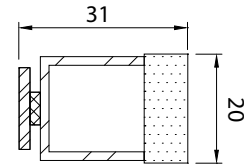

STRIP (S)

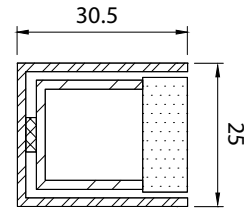

CHANNEL (C)

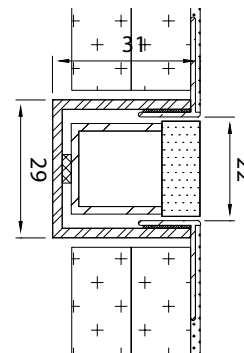

PLASTER (PLS)

Photometric Info

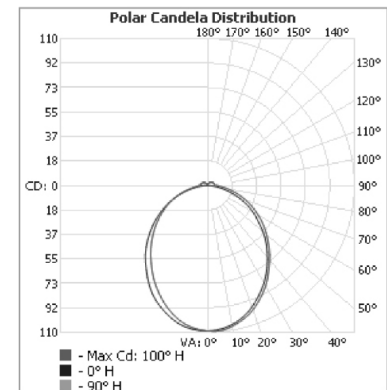

The Light Lab
 22 Holywell Row
 London EC2A 4JB
 United Kingdom
 +44 (0) 207 278 2678
 @thelightlabtd
 www.thelightlab.com

Product Details GL25

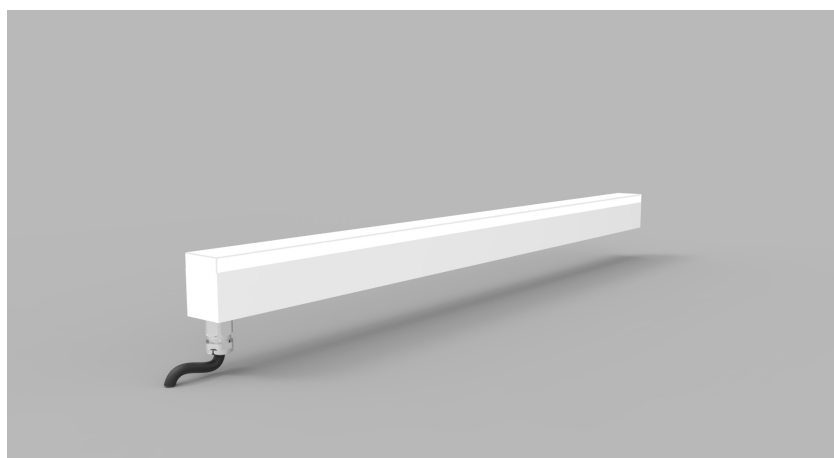

Specification

	SO	HO	SHO
Length	Any length up to 3.0m	Any length up to 3.0m	Any length up to 3.0m
Colour	3.0K/4.0K/5.0K	2.7K/3.0K/3.5K/4.0K/5.0K	
Input Voltage	24Vdc	24Vdc	24Vdc
Power Consumption	9.6 W/m	14 W/m	18 W/m
Luminaire Efficiency	56 lm/W	78 lm/W	78 lm/W
IP Rating	IP44 or IP65	IP44 or IP65	IP44 or IP65
Type	Flush or Proud	Flush or Proud	Flush or Proud

Order code

GL25-LENGTH-OUTPUT-COLOUR-TYPE-IP-FIXING
e.g. GL25-XXmm-SO-2.7K-FLUSH-IP44-VC

WIDTH	LENGTH	OUTPUT	COLOUR	TYPE	IP	FIXING
GL25	XXmm	SO	2.3K	Flush	IP44	S
		HO	2.7K	Proud	IP65	C
		SHO	3.0K			PLS
			3.5K			
			4.0K			
			5.0K			

Drivers

non-dimmable power supplies:

1-10V /DALI/DMX dimmable power supplies to be ordered separately

Please call our sales team who will make sure specification suits application

Glowline by The Light Lab



Fixing Methods

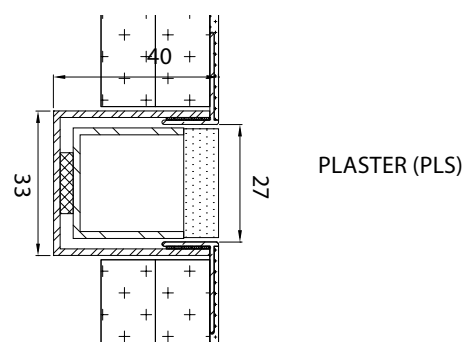
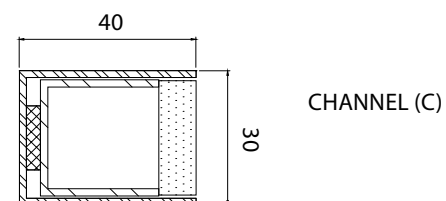
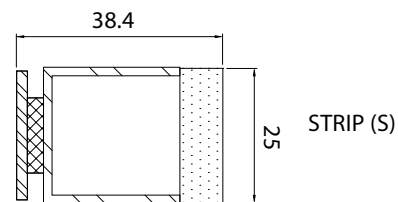

Photometric Info

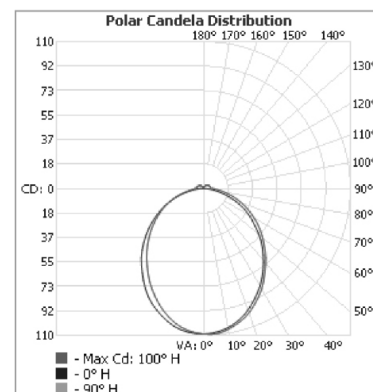

The Light Lab
22 Holywell Row
London EC2A 4JB
United Kingdom
+44 (0) 207 278 2678
@thelightlabltd
www.thelightlab.com

Product Details GL50

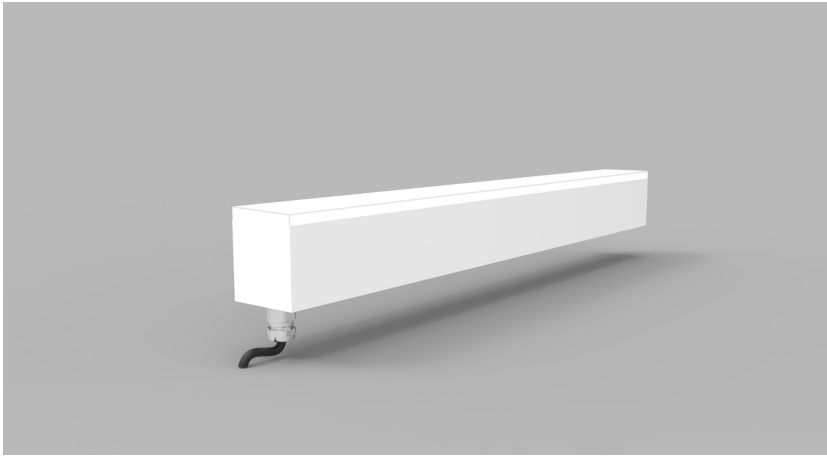

Specification

	SO	HO	SHO
Length	Any length up to 3.0m	Any length up to 3.0m	Any length up to 3.0m
Colour	3.0K/4.0K/5.0K	2.7K/3.0K/3.5K/4.0K/5.0K	2.7K/3.0K/3.5K/4.0K/5.0K
Input Voltage	24Vdc	24Vdc	24Vdc
Power Consumption	9.6 W/m	14 W/m	18 W/m
Luminaire Efficiency	56 lm/W	78 lm/W	78 lm/W
IP Rating	IP44 or IP65	IP44 or IP65	IP44 or IP65
Type	Flush or Proud	Flush or Proud	Flush or Proud

Order code

GL50-LENGTH-OUTPUT-COLOUR-TYPE-IP-FIXING
 e.g. GL50-1.2M-SO-2.7K-FLUSH-IP44-VC

WIDTH	LENGTH	OUTPUT	COLOUR	TYPE	IP	FIXING
GL50	XXmm	SO	2.3K	Flush	IP44	S
		HO	2.7K	Proud	IP65	C
		SHO	3.0K			PLS
			3.5K			
			4.0K			
			5.0K			

Drivers

non-dimmable power supplies:
 1-10V /DALI/DMX dimmable power supplies to be ordered separately

Please call our sales team who will make sure specification suits application

Glowline by The Light Lab



Fixing Methods

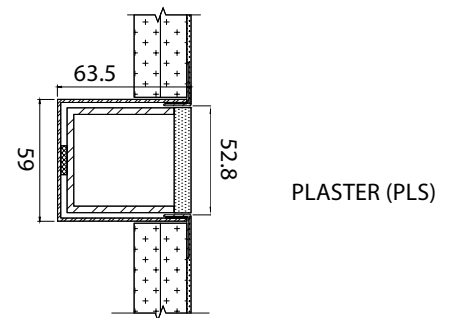
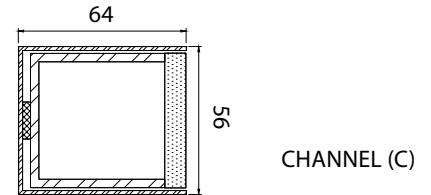
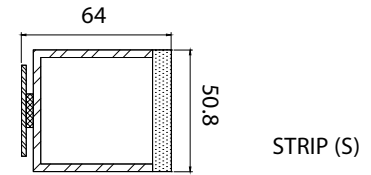

Photometric Info

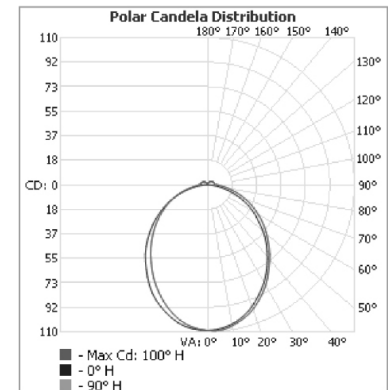

The Light Lab
 22 Holywell Row
 London EC2A 4JB
 United Kingdom
 +44 (0) 207 278 2678
 @thelightlabtd
 www.thelightlab.com

Project Images

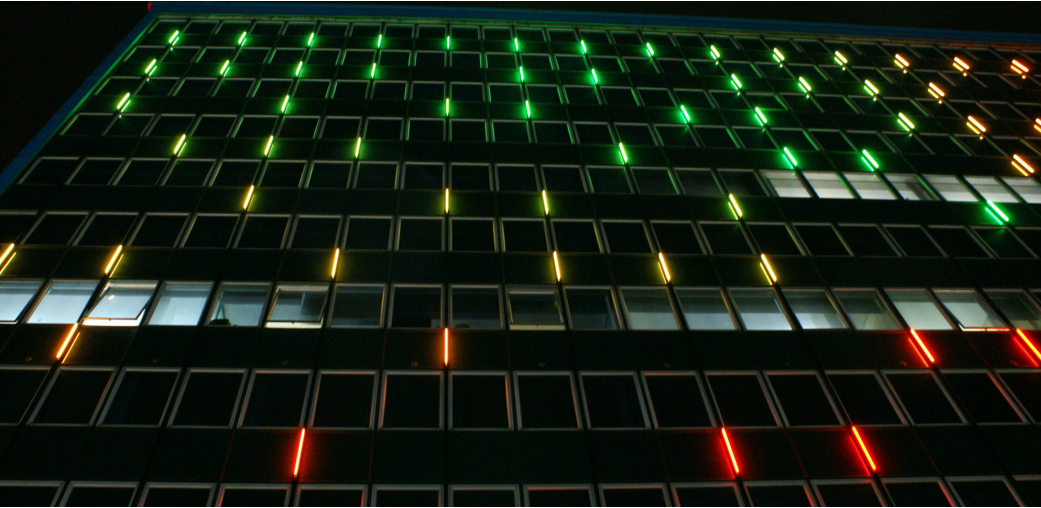

International House, Ashford



Liberty Specialist Markets

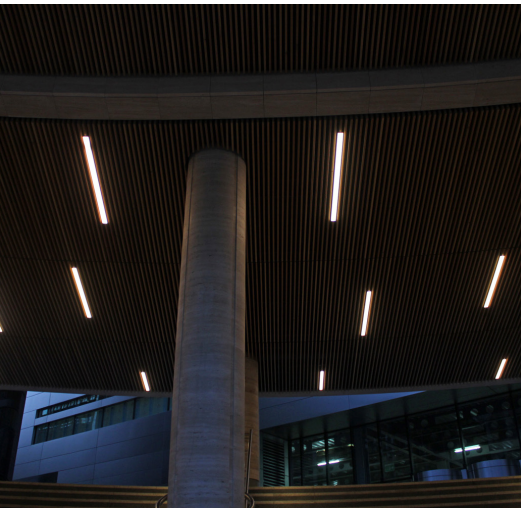

Broadgate Circle



30 Cannon Street



Admiral Insurance, Newport



Breakspeare Park



Sun Court, London

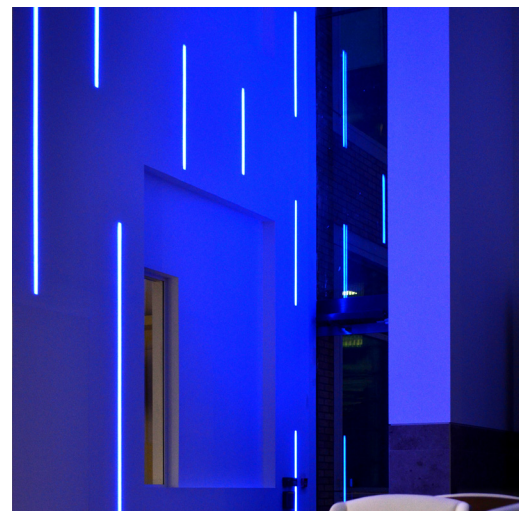

Lakeview, Manchester